

Owner's Manual

Reading Guidance

For Velotric Tempo series users, we provide instructional videos and the following documents:

- User Manual
- Assembly Instructions

We recommend watching the "Assembly Video Tutorial" and reading the Assembly Instructions first, then proceed with the rest of the User Manual for usage information.

Accessing Video Tutorials:

Scan the QR code below or visit the provided link to watch instructional videos, ensuring the correct and safe use of your product.



<https://velotricbike.info/arbl005>

Velotric App User Guide:

Scan the QR code below for step-by-step instructions on how to download and set up the App.



<http://velotricbike.info/3SzhKUN>

Table of Contents

PRODUCT OVERVIEW	05
eBike Diagram	06
Display Interface	09
Remote Diagram	10
ASSEMBLY INSTRUCTIONS	11
Package Contents Checklist	12
Assembly and Installation	14
Tire Pressure Check	24
Battery & Charging	25
Indicator Status	28
Recommended Torque Values	29
Pre-Ride Assembly Checklist	31
SAFETY GUIDELINES & CONDITIONS OF USE	33
Safety Guidelines	34
Conditions of Use	35
Disclaimer	36
QUICK START GUIDE	37
Pre-Ride Preparation	38
Operation Guide	41
Display Functions	42
Connect to Velotric App	46
Apple Find My/Android Find Hub	47
Display Detailed Guide	63

MAINTENANCE & CARE	85
Maintenance Schedule	86
Storage Guidelines	87
TROUBLESHOOTING & SERVICE	91
WARRANTY POLICY	95
Limited Warranty Terms	96
This Limited Warranty Does Not Cover	96

PRODUCT OVERVIEW

Meet Your Velotric Tempo Series eBike

Thank you for choosing the Velotric Tempo Series eBike. Powered by Velotric's signature innovations—ComfortMax™, SensorSwap™, and advanced safety—The Tempo combines stylish, rugged and effortless lightness—a natural path to fitness and freedom on every ride.

eBike Diagram	06
Display Interface	09
Remote Diagram	10

eBike Diagram

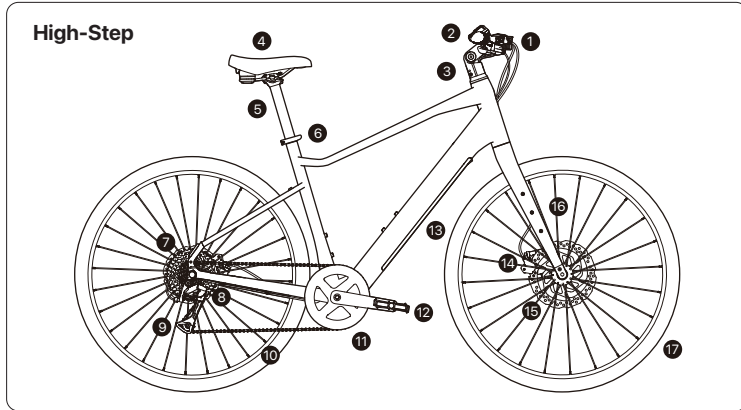

- | | | |
|------------------|-------------------|------------------|
| 1 Front Light | 7 Motor | 13 Battery |
| 2 Handlebar | 8 Freewheel | 14 Brake Caliper |
| 3 Stem | 9 Rear Derailleur | 15 Brake Rotor |
| 4 Saddle | 10 Chain | 16 Fork |
| 5 Seatpost | 11 Crankset | 17 Tire |
| 6 Seatpost Clamp | 12 Pedal | |

eBike Diagram

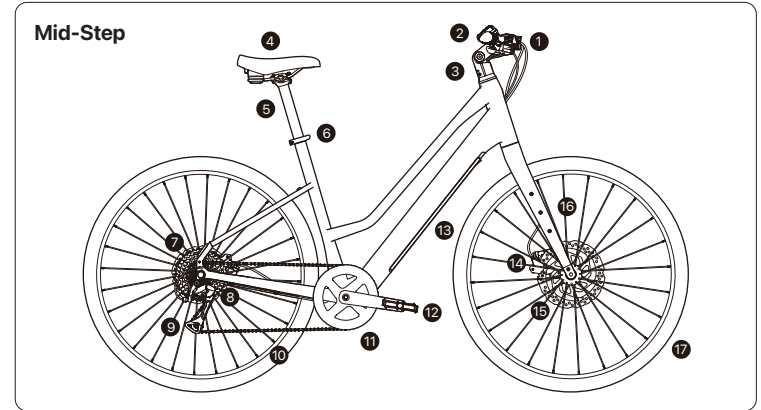

- | | | |
|------------------|-------------------|------------------|
| 1 Front Light | 7 Motor | 13 Battery |
| 2 Handlebar | 8 Freewheel | 14 Brake Caliper |
| 3 Stem | 9 Rear Derailleur | 15 Brake Rotor |
| 4 Saddle | 10 Chain | 16 Fork |
| 5 Seatpost | 11 Crankset | 17 Tire |
| 6 Seatpost Clamp | 12 Pedal | |

eBike Diagram

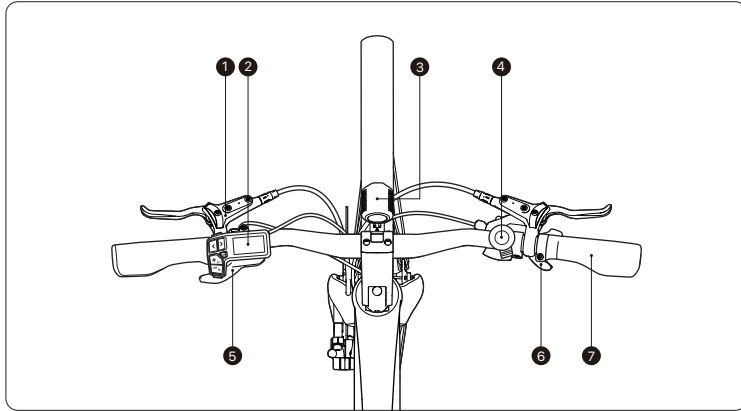

- | | |
|---------------|-----------|
| 1 Brake Lever | 5 Remote |
| 2 Display | 6 Shifter |
| 3 Light | 7 Grip |
| 4 Bell | |

Display Interface

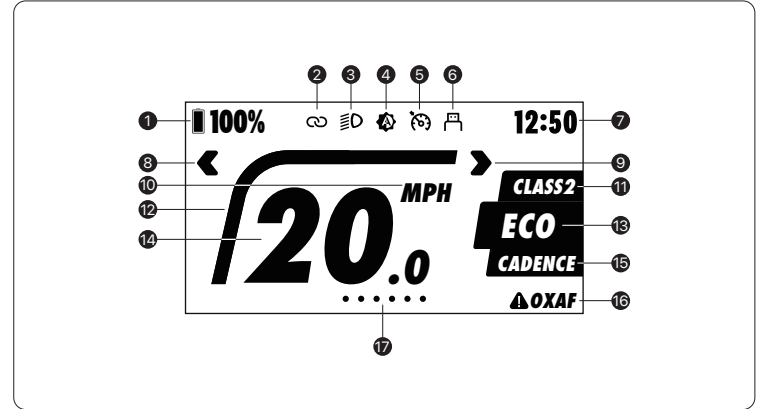

- | | | |
|-----------------------|----------------------|---------------------|
| 1 Battery Level | 7 Time | 13 Riding Mode |
| 2 Phone Connection | 8 Left Turn Signal | 14 Real-Time Speed |
| 3 Light | 9 Right Turn Signal | 15 Sensor Mode |
| 4 Adaptive Brightness | 10 Speed Unit | 16 Error Code |
| 5 Cruise Control | 11 Speed Limit Class | 17 Riding Data Page |
| 6 USB Port Charge | 12 Power Bar | |

Remote Diagram

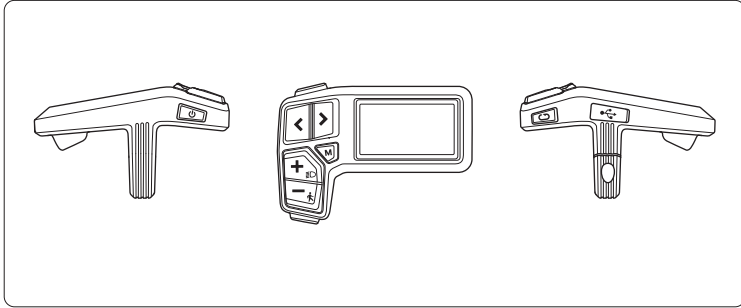

Long press:
· Power on/off



Single press:
· Turn on/off left turn signal



Single press:
· Turn on/off right turn signal



Single press:
· Increase/decrease riding mode



Long press:
· Turn on/off front and rear lights



Long press:
· Enter Walk Mode screen. Keep holding or tapping again after release to start walking assist.



Single press:
· Switch speed limit class
Long press:
· Enter cruise control mode



Single press:
· Switch riding data
Long press while stationary:
· Enter MENU
Long press while riding:
· Swap sensor mode



Type-C Charging Port

ASSEMBLY INSTRUCTIONS

Your Velotric Tempo series bike ships partially assembled. Follow these Assembly Instructions to complete setup before use.

Package Contents Checklist

Unpack and check all items against this list. Inspect the bike for shipping damage. Contact Velotric Customer Service if anything is damaged, missing, or unclear.

Package Contents Checklist	12
Assembly and Installation	14
Tire Pressure Check	24
Battery & Charging	25
Indicator Status	28
Recommended Torque Values	29
Pre-Ride Assembly Checklist	31

Package Contents Checklist

MANUAL & TOOLS

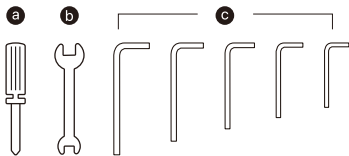

- a** Phillips Screwdriver
- b** 15mm/8mm Wrench
- c** 6mm/5mm/4mm/3mm/2.5mm Allen Key



Owner's Manual

PEDAL



Left Pedal



Right Pedal

Package Contents Checklist

ACCESSORIES

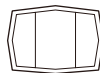

Front Reflector

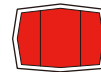

Rear Reflector

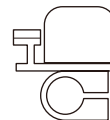

Bell

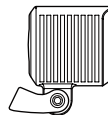

Front Light

CHARGER

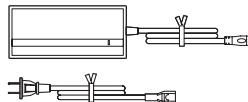

Adapter & Charging Cable

Assembly and Installation

Handlebar

1. Use a 4mm Allen key to remove the handlebar stem cap.
2. Insert the handlebar into the stem and pre-lock it (ensure that the handlebar is securely in place without any play).
3. Adjust the handlebar to a comfortable riding position, ensure it is centered, and align the two center guide lines with the middle of the stem cap. Use a 4mm Allen key to tighten the handlebar stem cap in an X-pattern.

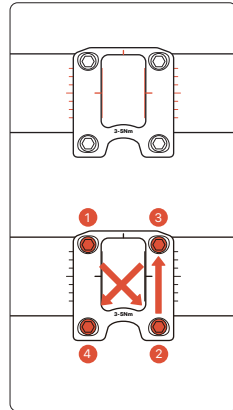
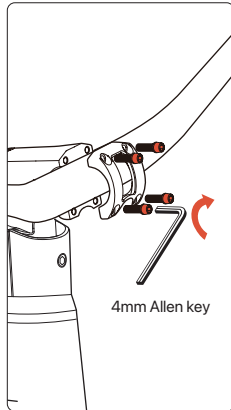
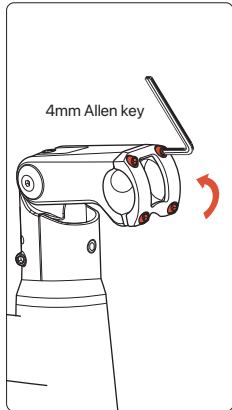

Assembly and Installation

Handlebar

4. Adjust the stem to make the handlebar perpendicular to the front wheel.
5. Route the right Brake Cable through the cable organizer. Align the arrows on the connectors and plug them together firmly.
6. Route the Brake, Display, and Throttle Cables through the left cable organizer. Match the corresponding connectors, align the arrows, and plug them in.

▲ **CAUTION** Ensure even spacing above and below the stem cap. Torque: 6-8 Nm.

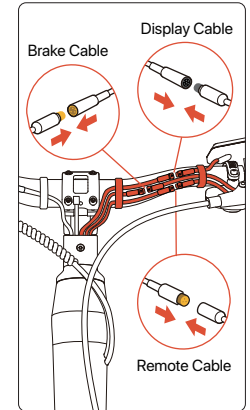
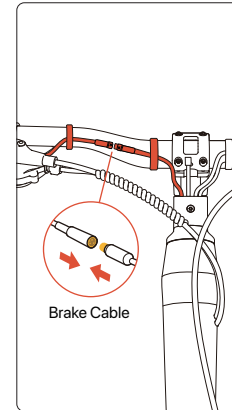
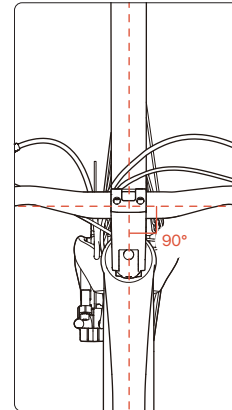

Assembly and Installation Adjustable Stem and Handlebar Adjustment

1. Use a 6mm Allen key to loosen the screw at the right side of the handlebar stem.
2. Gently lift the handlebar and adjust it to the desired angle. Then tighten it. Torque: 14 Nm.
3. Use a 4mm Allen key to loosen the four screws on the handlebar stem cap.

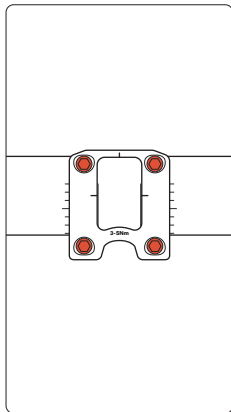
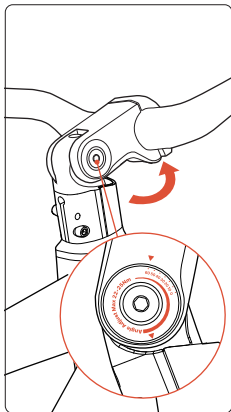
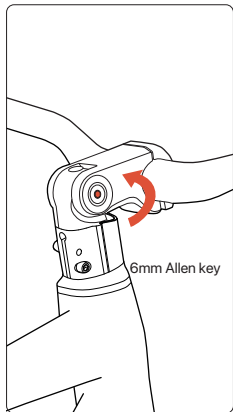

Adjustable Stem and Handlebar Adjustment **Assembly and Installation**

4. Use a 6mm Allen key to tighten the screw at the right side of the handlebar stem.
5. Adjust the handlebar (ensure the straight section of the handlebar is parallel to the ground).
6. Use a 4mm Allen key to tighten the handlebar stem cap screws in an X-pattern to ensure even spacing above and below the stem cap. Torque range: 6-8 Nm.

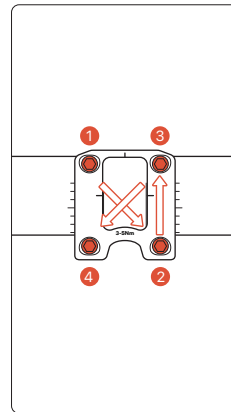
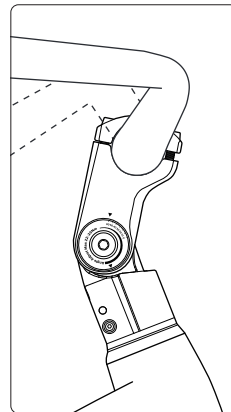
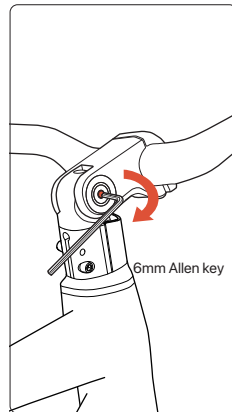

Assembly and Installation

Front Wheel

1. Use a 6mm Allen key to loosen the axle rod.
2. Remove the plastic base of the front fork.

Note Make sure the brake rotor is aligned with the brake caliper pads, so the brake rotor can easily enter the caliper without any friction.

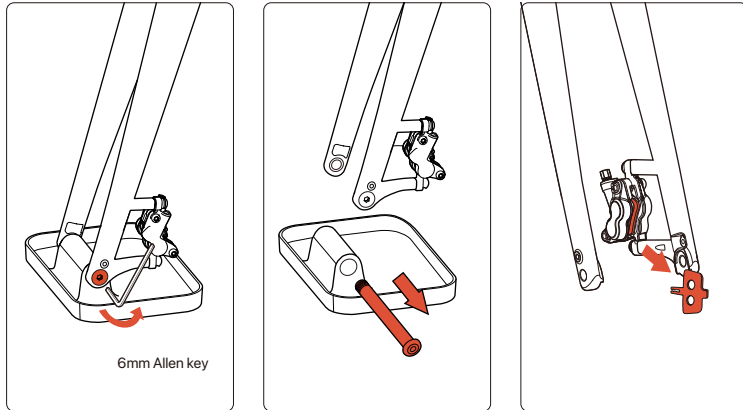

Front Wheel

Assembly and Installation

3. Lift the front of the Ebike and insert the front wheel hub into the installation slot on the front fork. Ensure that the disc fits into the caliper with brake pads in the middle.
4. Align the mounting hole and insert the axle shaft. Confirm smooth threading, and then tighten it using a 6mm Allen key. Torque: 14 Nm.
5. Check and adjust the disc brakes to ensure they do not rub or produce any unusual sounds.

CAUTION Be careful not to accidentally squeeze the brake levers before the front wheel is installed. Otherwise, you may cause misalignment on your hydraulic brakes.

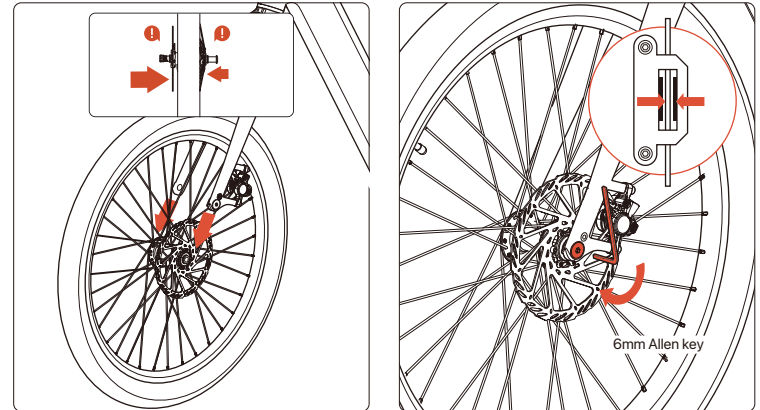

Assembly and Installation

Front Light

1. Align the front light bracket with the mounting port on the handlebar stem cap and securely fasten the screw. Torque range: 2.5~5.5 Nm.
2. Align the power cable with the arrow and connect it.
3. Use a screwdriver and an open-end wrench to tighten the nut. Torque range: 2.5~5.5 Nm.

Note Before traveling at night, please check the front light to ensure it functions properly.

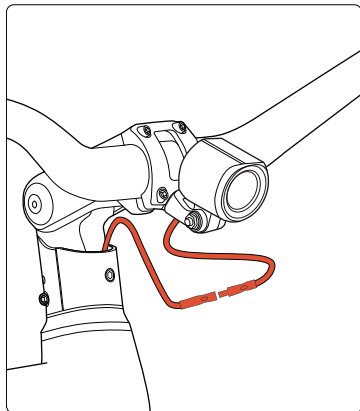
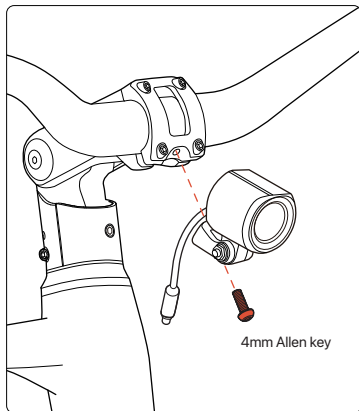

Bell and Front/Rear Reflector

Assembly and Installation

1. Use a Phillips screwdriver to remove the screws from the bell. Then slide the bell onto the right side of the handlebar and adjust the angle and tighten using a screwdriver.
2. Use a Phillips screwdriver to sequentially remove the screws from the front and rear reflectors and set them aside.
3. Place the gasket inside the mounting ring of the front reflector and slide it onto the handlebar. Adjust the angle (perpendicular to the ground at a 90° angle) and tighten using a screwdriver.

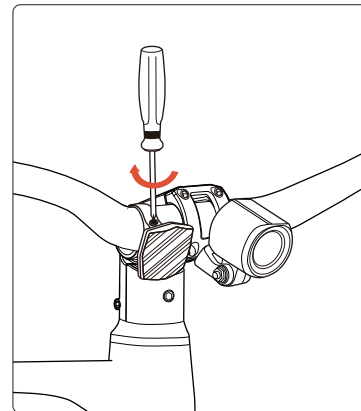
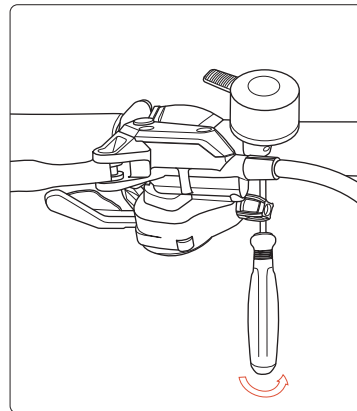

Assembly and Installation

Bell and Front/Rear Reflector

- Slide the mounting ring of the rear reflector onto the seatpost (position it between 30-50mm from the top)
- Ensure it is not obstructed and ensure the reflector is vertical to the ground.

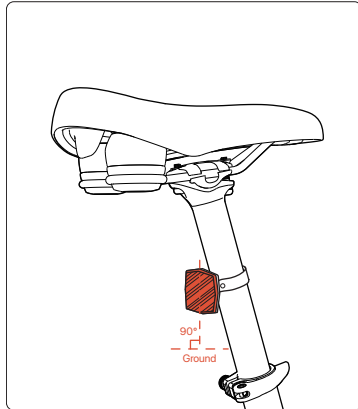
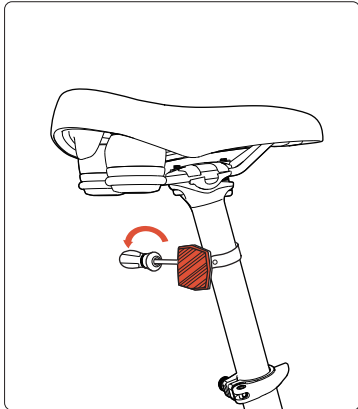

Pedals

Assembly and Installation

- Identify each pedal by the sticker on the pedal axle: "L" indicates the left pedal and "R" indicates the right pedal.
- Install the right pedal. Carefully thread in the right pedal by hand, turning clockwise, as shown in the illustration below.
- Tighten the right pedal securely with a 15mm wrench.
- Install the left pedal. Carefully thread in the left pedal by hand, turning counter-clockwise, as shown in the illustration below.
- Tighten the left pedal securely with a 15mm wrench. Torque range: 35 Nm to 40 Nm

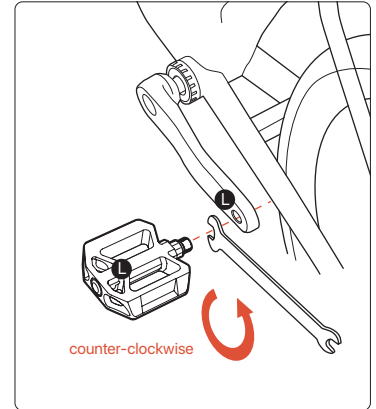
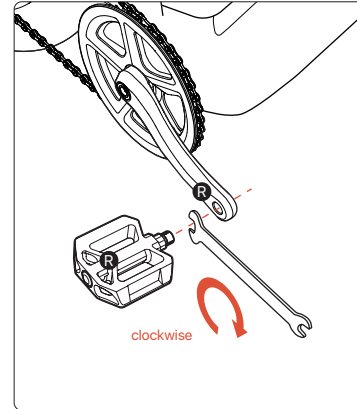

Tire Pressure Check

1. Check tire pressure by hand, and if it's easily compressible, it indicates low pressure and needs inflation.
2. Use an inflation pump equipped with an AV interface.
3. Inflate the tire until it is no longer easily compressible (do not exceed the tire's maximum recommended pressure).
4. Follow the tire markings for the maximum recommended pressure.

Note Check tire pressure before every ride.

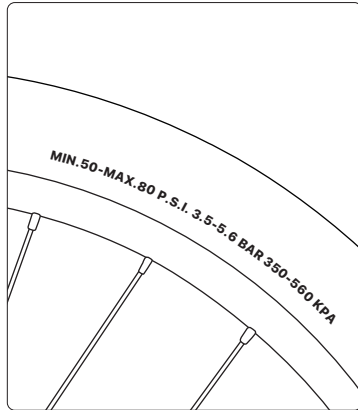
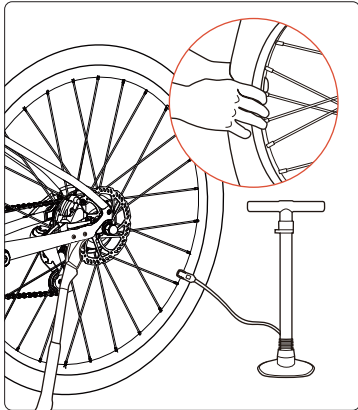

Activate Battery

Battery & Charging

Method A

1. Make sure the battery is securely installed.
2. Charge the eBike for over 5 seconds to activate the battery.

Method B

1. Remove the battery: Disconnect the charger, turn the key, then remove the battery.
2. Activate the battery: Press and hold the battery power button for 5 seconds. When the battery indicator lights up, it indicates that the battery is activated.
3. Reinstall the battery: Align the battery with the battery compartment and slide it in. Press the battery with your hand until you hear a clicking sound.

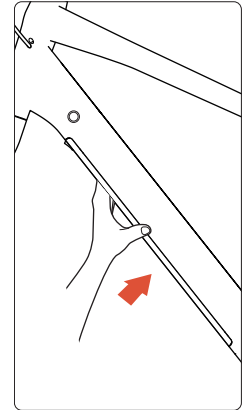
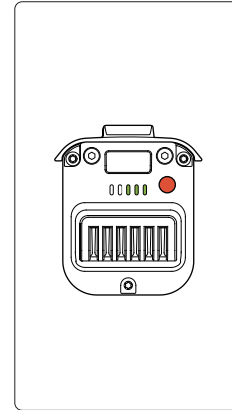
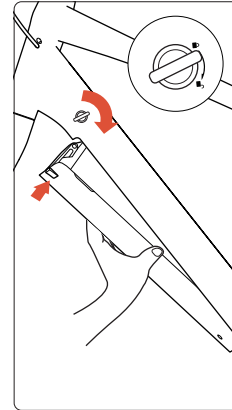

Battery & Charging

Charge the Battery

The battery can be charged either in or out of the eBike.

A. Charging on the eBike:

1. Power off the eBike before charging the battery in the eBike.
2. Insert the charging cable plug into the eBike's charging port. The LED indicator will turn red, and the screen will display that the vehicle is in charging mode.
3. The indicator will turn green when the battery is fully charged. Unplug the charger first before pulling out the cord from the battery.

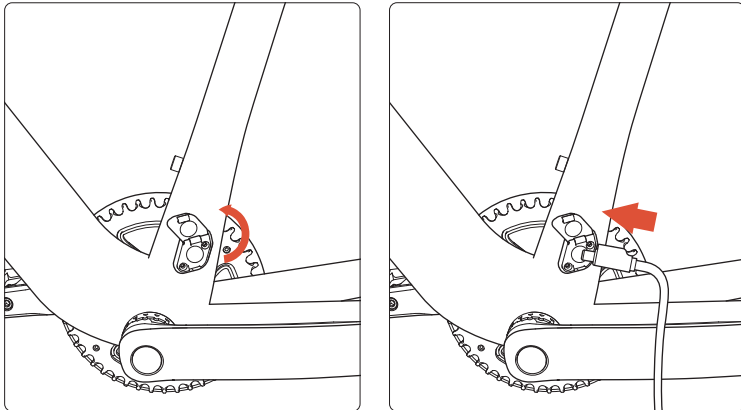

Charge the battery

Battery & Charging

B. Removing the Battery for Charging:

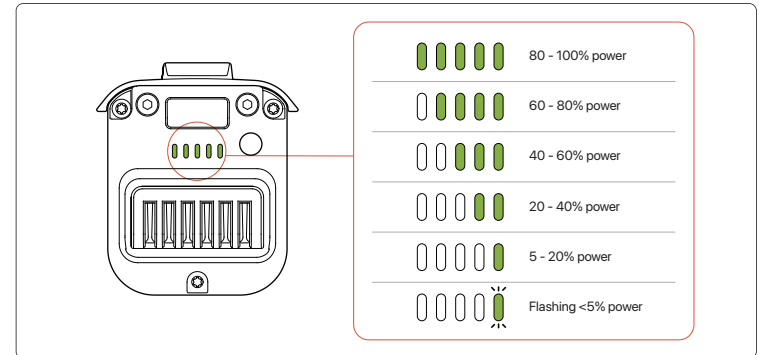

1. Make sure the battery is placed on a flat and clear surface. Plug the DC charging cable (barrel connector) into the port.
2. Plug in the charger, the LED indicator will turn red and the battery indicator will flash.
3. The indicator will turn solid green when the battery is fully charged, and the battery's charge indicator will blink. Unplug the charger before disconnecting the cable from the battery.

- ▲ **WARNING**
1. Charge the battery in an environment from 50–86°F (10–30°C).
 2. The battery won't charge when it is over 113°F (45°C) or below 32°F (0°C). Let the battery adjust to room temperature for at least 1 hour before trying again.

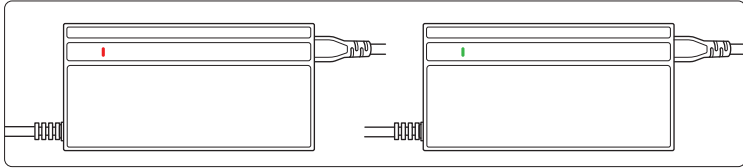

Indicator Status



Color	Indicator Status	Description
Red	Solid on 	The battery is charging
Green	Solid on 	The battery is fully charged

Note While charging, the charger indicator turns solid red from green and turns solid green when the battery is fully charged.

▲ CAUTION When the battery is not charging, you can press the indicator button on the top of the battery to see the battery's charge level.

Recommended Torque Values

Always tighten the fasteners to the correct torque. Too much torque can stretch, deform, or break a fastener or the part it attaches to or tightens. Too little torque can allow the part to move and may lead to fatigue and breakage of the fastener or the attached part. Either mistake can lead to a sudden failure of the fastener, causing you to lose control and fall.

Category	Fastener	Tool	Torque Spec. (Nm)
Handlebar section	Grip clamp bolts	M3 Allen key	1.5-2
	Stem clamp bolts	M4 Allen key	12
	Shifter clamp bolt	M5 Allen key	3-5
	Throttle clamp bolt	M3 Allen key	2-3
	Display clamp bolts	M2.5 Allen key	1.5-2
	Brake lever clamp bolts	M5 Allen key	7-9
	Stem faceplate bolts	M4 Allen key	6-8
	Stem top cap bolt	M5 Allen key	8
Brake	Disc brake bolt	M5 Allen key	7-9
	Disc brake adapter bolt	M5 Allen key	7-9
	Brake rotor clamp bolts	T25 screw wrench	4-6
Saddle	Saddle adjustment bolt	M5 Allen key	12-14
Frame	Rear derailleur mounting bolt	M5 Allen key	8-12
	Derailleur cable clamp nut	M5 Allen key	5.5-6.5
	Motor axle nuts	19mm wrench	31-35

Pre-Ride Assembly Checklist

Before your first ride, ensure your eBike is correctly assembled, secured, and tightened to recommended specifications. Regularly check all parts and hardware. Loose or damaged grips affect control and safety. Check off each item:

- Front Wheel Installed?
- Fenders Installed?
- Handlebar Installed?
- Handlebar Adjusted?
- Front light Installed?
- Display Installed?
- Front & Rear Reflectors Installed?
- Pedals Installed & Tightened?
- Battery Activated?
- Tire Pressure Checked & Inflated?
- App Downloaded & Bike Registered?
- Safety Summary and User Manual Read?

SAFETY GUIDELINES & CONDITIONS OF USE

Safety Guidelines	34
Conditions of Use	35
Disclaimer	36

Safety Guidelines

All users MUST read and understand this manual BEFORE using the Velotric eBike. Additional manuals may be included for components; read those before installation or use. Failure to follow these guidelines can result in serious injury or death. You are responsible for knowing and obeying all local laws and regulations regarding eBike use.

Pre-Ride Precautions

- ▲ **WARNING** Incorrect battery charging, storage, or use voids warranty and can be hazardous. Check brake cut-off function before every ride (brake system includes a motor cut-off switch).

- ▲ **WARNING** eBikes are heavier and faster than regular bikes. Ride with extra caution, especially on wet surfaces. Reduce speed and increase braking distance. Slippery conditions can cause loss of control, leading to serious injury or death.

- Ensure the bike size fits you correctly before first use. An ill-fitting bike can cause loss of control or falls.
- ALWAYS wear a certified bicycle helmet and follow the manufacturer's instructions. Not wearing a helmet can cause serious injury or death.
- Before your first ride, ensure the bike is correctly assembled and tightened to recommended specs. Regularly check all parts and hardware. Ensure grips are undamaged and secure. Loose or damaged grips affect control and safety.

- Note** Failure to ensure proper installation, compatibility, operation, or maintenance of any part or accessory can cause serious injury or death. After any accident, do NOT ride. Have the bike thoroughly inspected by a certified technician.

- Use pedal assist (PAS) and throttle carefully. Be prepared: the assist starts when you begin pedaling.

- Understand how the thumb throttle and pedal assist sensor work before riding. Ride cautiously according to conditions, terrain, and experience. Control your speed. Start on the lowest assist level until you are comfortable controlling the bike.

Off-Road & Extreme Riding

- Off-road riding requires focus, specific skills, and involves variable terrain and hazards. Wear appropriate safety gear, avoid riding alone in remote areas, and follow local laws.
- NEVER perform extreme riding. This includes, but is not limited to, jumping, stunts, or riding beyond your ability. Extreme riding is not recommended and is prohibited. It can cause serious injury or death. Bikes and components have strength and durability limits. Extreme riding can damage parts and create serious hazards.

Conditions of Use

- ▲ **WARNING** Riding in low visibility (night, dawn, dusk, fog, rain, snow) is extremely dangerous. Hazards are harder to see, and you are harder for others to see, increasing the risk of accident, serious injury, or death. Wet and uneven surfaces increase this risk.

Riding in Wet Weather

- Wet weather reduces traction, braking effectiveness, and visibility for everyone. Ride with extreme caution.
- Avoid riding in these conditions if possible. If you must ride:
 - Ride slowly.
 - Stay alert, ride defensively, anticipate hazards.
 - Avoid dark areas and heavy traffic.
 - Wear reflective or light-colored clothing.
 - Use front and rear lights.

Riding in Low Visibility

QUICK START GUIDE

- Avoid riding in these conditions if possible. If you must ride:
 - Ride slowly.
 - Stay alert, ride defensively, anticipate hazards.
 - Avoid dark areas and heavy traffic.
 - Wear reflective or light-colored clothing.
 - Ride familiar routes if possible.
 - Ensure front and rear lights are working and unobstructed.
 - Ensure front and rear reflectors are correctly positioned, secure, and unobstructed.

Weight Limit

▲ **WARNING** NEVER exceed the maximum weight limit. Overloading voids warranty and can cause component failure, loss of control, serious injury, or death.

- The total maximum weight capacity (including bike, rider, passenger, clothes, cargo, accessories) is 440 lbs.

Disclaimer

- Do NOT remove any reflectors.
- Do NOT use this product with trailers, racks, or carriers not tested or certified by Velotric.
- Any modification not explicitly approved by Velotric Bikes voids the warranty and can create dangerous riding conditions.

Pre-Ride Preparation	38
Operation Guide	41
Display Functions	42
Connect to Velotric App	46
Apple Find My/Android Find Hub	47
Display Detailed Guide	63

Pre-Ride Preparation

Safety Check

- Ensure that the handlebar cables were routed correctly when the handlebar was installed. Turn the handlebar fully to the left and right and ensure that no cables or wires can be taut.
- Ensure that the pedals are secured with a pedal wrench according to the torque value listed in "Recommended Torque Values".
- Ensure that the cable connectors on the eBike are all plugged in securely and that nothing loosened in shipping.
- Check the brake functions per the directions in the "Brake System Inspection".

It is normal that brakes can rub a little the first few times you ride. Any squeaks or noises will disappear with use.

Standover Height

When selecting a new eBike, the correct choice of frame size is the most basic safety consideration.

Standover height is the basic element of eBike fitness. It is the distance from the ground to the top of the eBike frame at the point where your inseam is when straddling the eBike with both feet flat on the ground.

There should be a clearance of 1 inch to 2 inches (25.4 mm to 50.8 mm) between your crotch and the top tube of the eBike.

If your crotch touches the frame, it indicates that the eBike is too big for you.

To check for the correct standover height, straddle the eBike while wearing the kind of shoes in which you will be riding, and bounce vigorously on your heels.

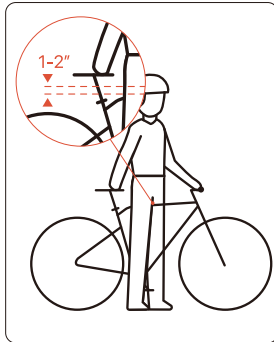

Helmet

Safety while cycling is of paramount importance. When riding a bicycle, always wear a properly fitting helmet and wear it correctly. Many places require the use of specific safety equipment. It is your responsibility to familiarize yourself with local laws, regulations, and ordinances in the area-in-which you're cycling and to comply with all applicable laws, including equipping yourself and your bicycle as required by law.

Chain Check

Ensure the chain is clean, well-lubricated, and runs smoothly. Be extra cautious when riding in wet, salty, corrosive, or dusty conditions.

Electrical System Check

- **Display:** Ensure the display cable is connected correctly and securely. Ensure the display is mounted securely, positioned correctly, and functions.
- **Motor Cut-off:** Ensure throttle, brake levers, and motor work correctly. Brake levers have built-in motor cut-off switches. Applying either brake should instantly cut motor power, even if the throttle is engaged. Get professional service if anything seems abnormal.
- **Lights:** Ensure front light and taillight are unobstructed. Ensure front light turns on/off via long-press of the [Light Button]. Ensure taillight brightens to a solid brake light when either brake lever is pulled.
- **Battery:** Ensure the battery shows no visible damage (cracks, dents, deformation). Ensure the battery is correctly locked in place before riding. Ensure sufficient battery charge. Refer to "Battery Indicator Status" and "Battery Storage".
- **Cables:** Ensure all cables are free of sharp bends or knots. Check for damage or wear. Ensure all cables and housings are correctly secured to frame/fork, avoiding interference with moving parts.

Brake System Check & Adjustment

Brakes are critical for safety. Test them before every ride.

- Ensure brakes are clean and free of debris.
- Ensure brake levers move smoothly and are securely mounted.
- Check brake pads and rotor for wear. Replace if excessively worn.
- Ensure the rotor is centered between the brake pads.
- Test both front and rear brakes individually.
- Squeeze levers: Feel should be firm. Brakes, motor cut-off, and taillight brake light must activate.
- While stationary, ensure you can apply full braking force without levers touching the handlebar. Adjust lever reach if needed (see below).

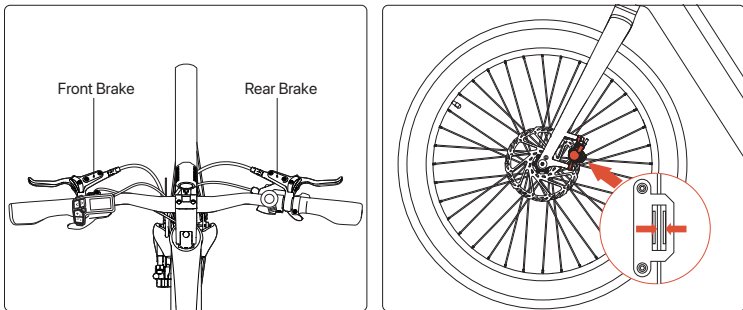

Brake Lever Position Adjustment

Most riders find the default position comfortable. Adjust reach or angle if needed:

1. Adjust Reach: Rotate the barrel adjuster (1) counter-clockwise to bring the lever closer to the bar; clockwise to move it farther away.
2. Adjust Angle:
 - Loosen the clamp bolt (2).
 - Rotate the lever to the desired angle.
 - Retighten the clamp bolt securely.

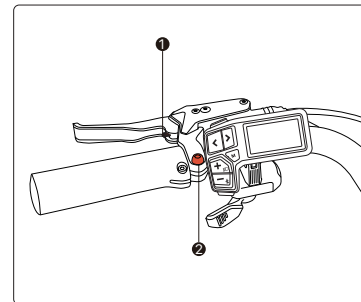



Note Ensure that the brake lever is parallel to the grip when a full brake is applied and you can hardly pull the lever closer to the grip.

Operation Guide

Power, Throttle & Pedal Assist (PAS)

- Power On/Off: Press and hold the [Power Button] for 2 seconds.
- Throttle: Press the throttle to move without pedaling. Release throttle to cut motor power.
- Pedal Assist (PAS): Motor provides power while pedaling. Motor stops when pedaling stops.
- Selecting Assist Level: Default level at startup is "0" (no motor assist). Press **+** or **-** buttons to change levels. Motor assist stops when the speed limit for the selected level is reached.

Display Functions

1. Please scan the QR code to find warranty information. Then peel the protective film off the display.
2. Long press the  button for 2 seconds to power on.
3. Single press the  or  button to increase/decrease the assist level.

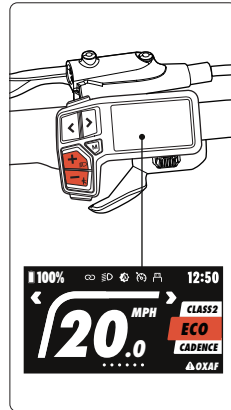
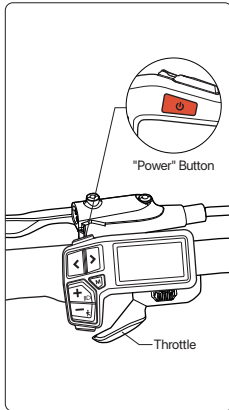
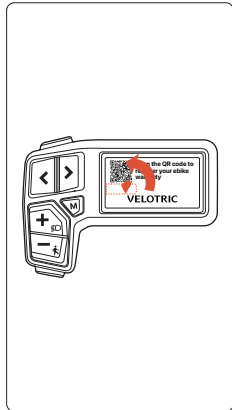

Display Functions

4. Long press the  button for 2 seconds to turn the front and rear lights on/off.

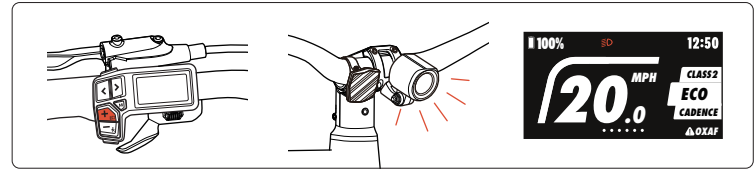

5. Press and hold the  button to activate the Walk Mode release the button to turn off.

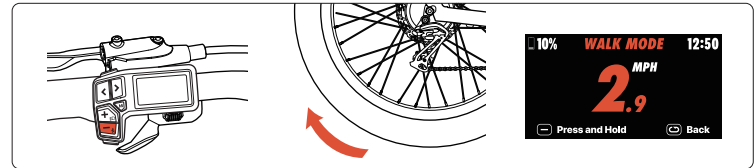

Display Functions

6. Single press the **M** button to switch riding data.
7. Long press the **M** button for 2 seconds to enter MENU.
8. Single press the **☰** button to switch speed limit class.

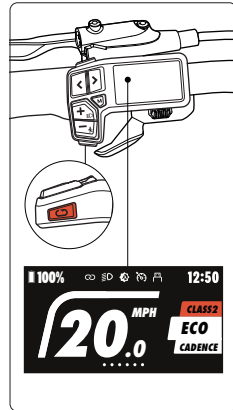
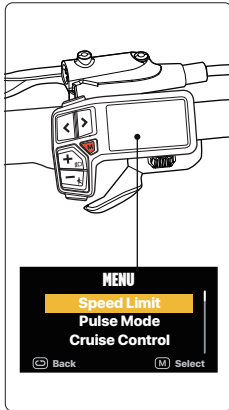
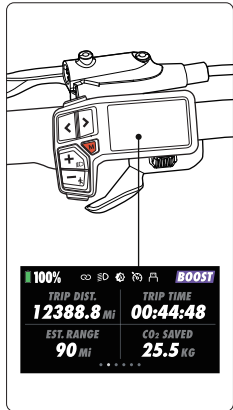

Display Functions

9. Single press the **☐** button to turn on left turn signal.

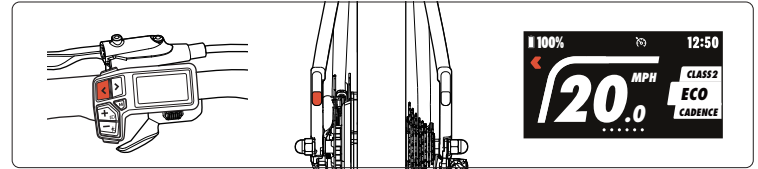

10. Single press the **☐** button to turn on right turn signal.

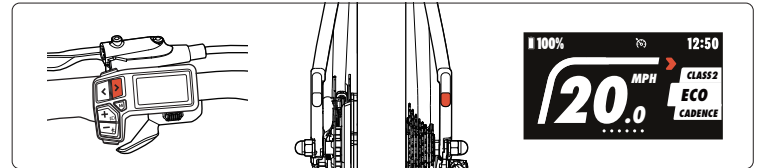

Connect to Velotric App

1. Long press the **[M]** button for 2 seconds to enter MENU.
2. Single press the **[←]** button to switch to "Connect to App". Then single press the **[M]** button.
3. Scan the QR Code displayed on the screen with Velotric App to pair your eBike.

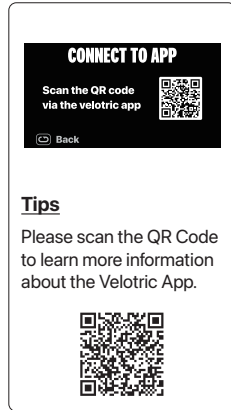
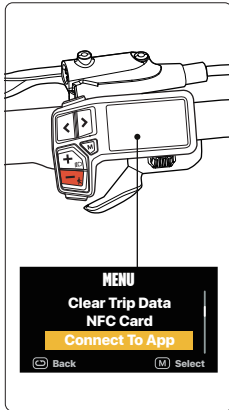
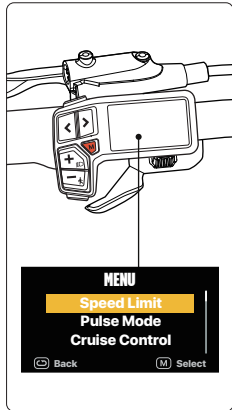

How to Connect My eBike

Apple Find My/Android Find Hub

Follow these steps to pair your eBike with the Find My app.

1. Long press the **[⏻]** button for 2 seconds to power on.
2. Long press the **[M]** button for 2 seconds to enter MENU, select "Find My", then single press the **[M]** button.
3. Select "Find My", and single press the **[M]** button. Once the eBike emits a sound, it is now ready to be paired.

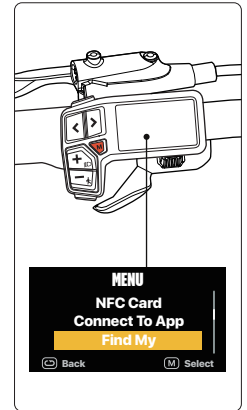
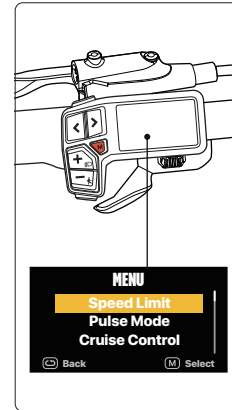
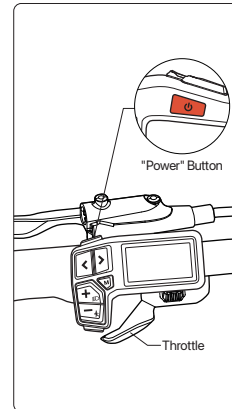

- When the display shows a "Success" prompt and emits a high-frequency tone, it indicates that it has entered pairing mode.
- Open the Find My app on your device. Under the "Items" section, tap "Add Item".



Tips:

- High-Frequency Tone:** Ready to pair
- Mid-Frequency Tone:** It has been paired
- Low-Frequency Tone:** The power is off.

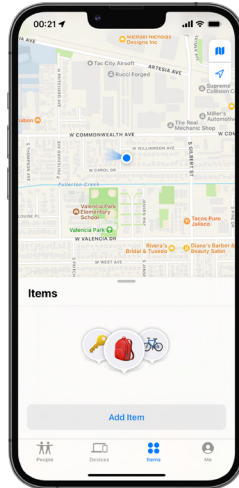

- Tap "Other Supported Item".
- When your eBike is detected, tap the "Connect" button. Follow the instructions within the Find My app to complete the pairing process.

Note Please complete the pairing within 5 minutes in the Find My app.

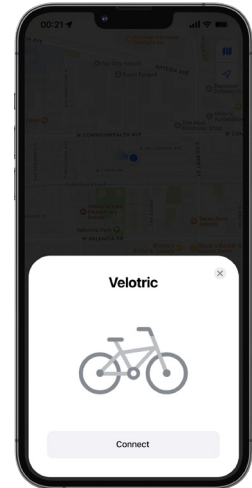
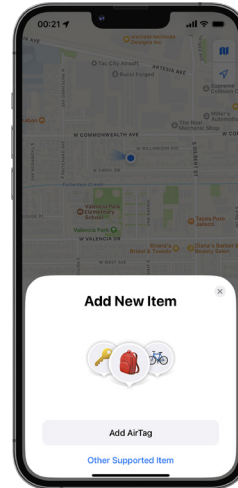

If your eBike is lost, please follow these steps to activate "Lost Mode" and locate your eBike.

1. Select your eBike from 'Items' list.
2. In Lost Mode, tap [Enable].

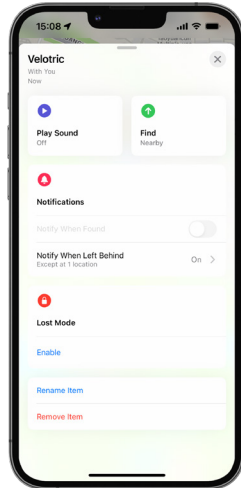
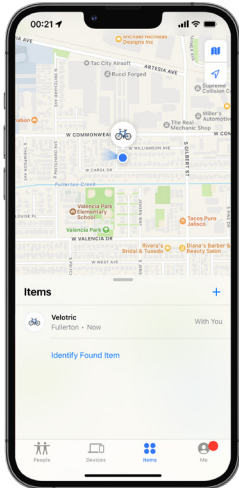

3. Read "WHAT WILL HAPPEN?" first, then tap [Continue].
4. Enter your phone number or email, then tap [Activate] to activate Lost Mode.

Note If your eBike is locatable, other users can tap [Identify Found Item] in the Find My app to help identify your eBike.

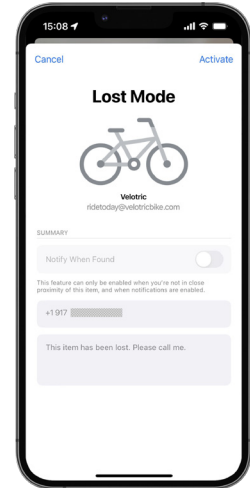
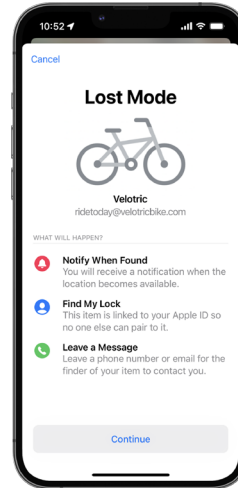

Once your eBike is found, follow these steps to turn off 'Lost Mode'.

1. Select your eBike from 'Items' list.
2. In Lost Mode, tap [Enabled].

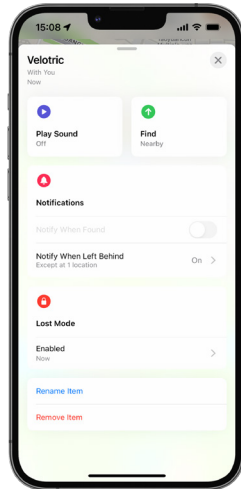
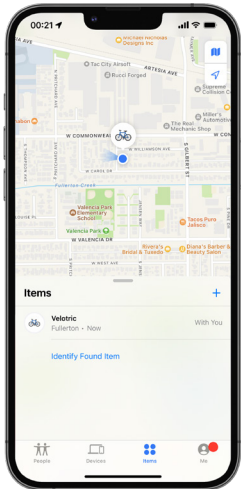

3. Tap [Turn Off Lost Mode]. You have now turned off Lost Mode.

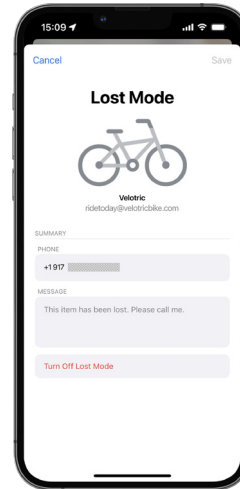

Follow these steps to remove your eBike from the 'Find My' network if you are no longer using this eBike.

1. Select your eBike from 'Items' list.
2. Scroll down to the bottom and tap [Remove Item].

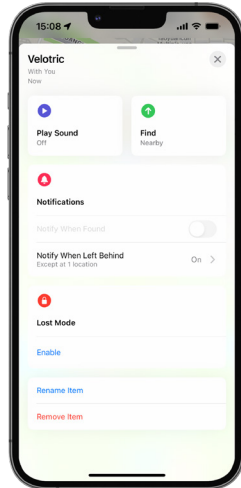
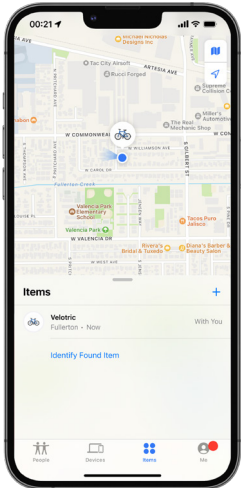

3. In the 'Remove Item' page, tap [Remove], and the eBike will be removed from your item list.

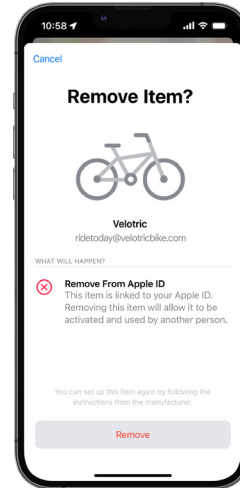

Android Find Hub

How to connect Find Hub

1. Turn on Bluetooth on your phone first, then open the Find Hub app. Wait for the vehicle card to slide up from the bottom of the screen.
2. When your eBike is detected, tap the [Connect] button. Follow the instructions within the Find Hub app to complete the pairing process.

Note Please complete the pairing within 5 minutes in the Find Hub app.

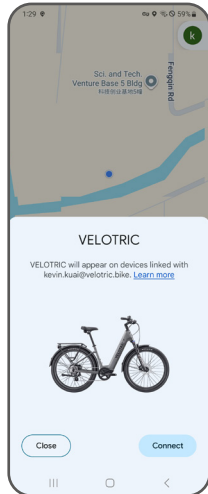
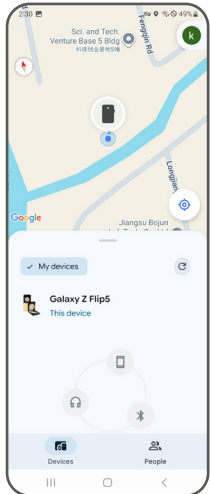

How to Enable Lost Mode

Android Find Hub

Follow these steps to remove your eBike from the 'Find My' network if you are no longer using this eBike.

1. If your eBike is lost, please follow these steps to activate "Lost Mode" and locate your eBike.
2. On this card, tap [Mark as lost] to report the bike as lost.

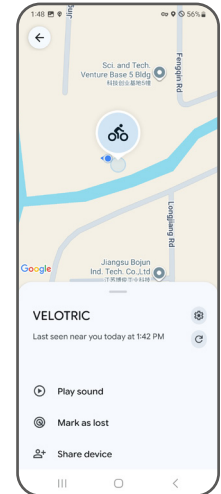
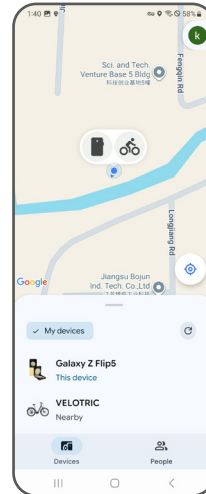

3. Read "How it works?" first, then tap [Continue].
4. Enter your phone number or email, then tap [Mark as lost] to activate Lost Mode.

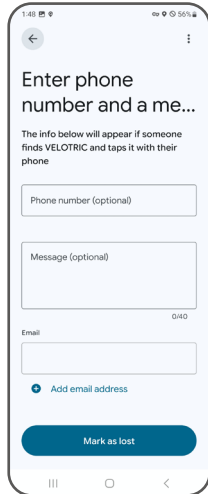
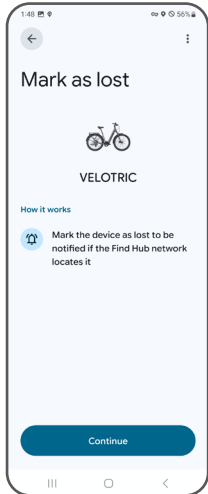

Once your eBike is found, follow these steps to turn off 'Lost Mode'.

1. On this card, tap "Mark as Found" to cancel the lost status of the bike.

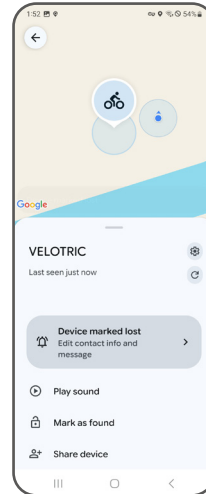

Follow these steps to remove your eBike from the 'Find Hub' network if you are no longer using this eBike.

1. Select your eBike from "Items" list.
2. Tap the [setting] in the top right corner of the card to enter the Device Details page.

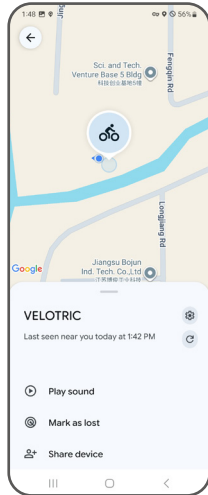
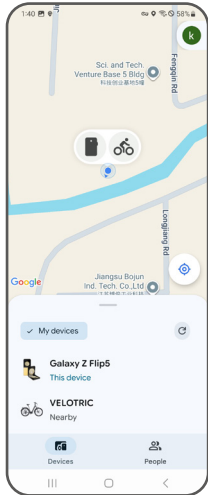

3. On this page, tap [Remove from Find Hub] to remove the bike.
4. In the "Remove from Find Hub" page, tap [Remove], and the eBike will be removed from your item list.

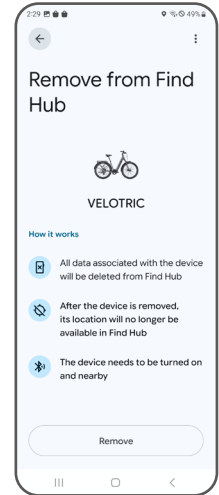
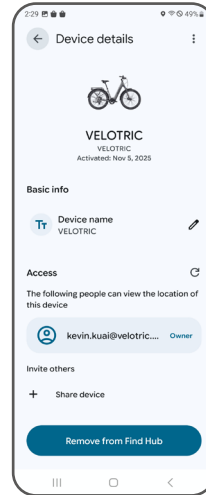

Apple Find My/Android Find Hub How to Restore Factory Setting

If the eBike is offline when removing from Find My app, restore factory setting will allow you to unpair the eBike.

1. Long press the **(U)** button for 2 seconds to power on. Long press the **(M)** button for 2 seconds to enter MENU. Select "Find My" and then single press the **(M)** button.
2. Select [Restore Factory Setting] and single press the **(M)** button. Next, select [Confirm] and single press the **(M)** button again. When you see the 'Success' prompt and hear the eBike emit a sound, the factory reset was successful.

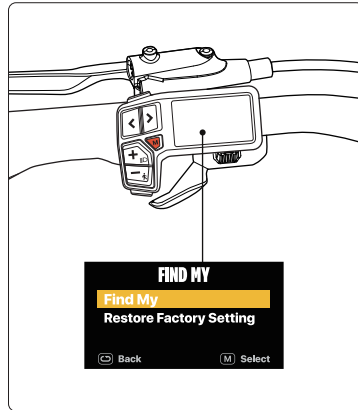
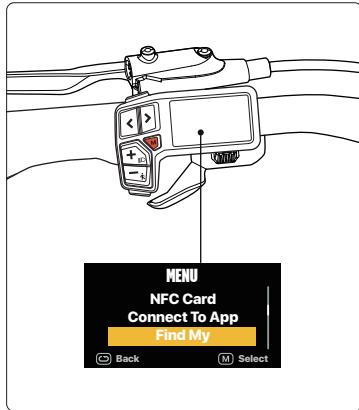

Display Detailed Guide

Battery Indicator

The battery indicator can display two statuses. When the battery level is lower than 20%, the color will turn yellow to remind you to get the battery charged.

When the battery is depleted, the vehicle control system will activate the low-voltage protection mode, cutting off the vehicle's power output and displaying a 'Low Battery' alarm on the dashboard. Upon seeing the alarm, please connect the power supply to recharge the battery. Note that prolonged battery depletion can jeopardize the battery's lifespan.



Walk Mode

1. Press and hold the **(-)** button for 3 seconds to enter Walk Mode standby.
2. Then, hold the **(-)** button for over 1 second to activate Walk Mode. The screen will display the walk speed (e.g., 2.9 mph).
3. Release the **(-)** button to pause walking. The bike enters anti-rollback state. To resume, press and hold the **(-)** button again for 1+ second.
4. Press the **(U)** button to exit Walk Mode. Interface shown as the diagram:

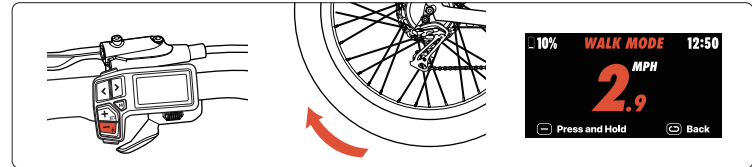

Phone Connection

Your eBike can be connected to the Velotric App via Phone Connection.



Light

Long press the **[+]** button for 2 seconds to turn on/off the front and rear lights.



Light on

If the Auto Front light is ON, the light icon will be displayed like the diagram:



Auto Light

Adaptive Brightness

By setting your screen brightness to "Auto," your display will automatically change its brightness level in relation to the amount of light in your immediate surroundings.



Cruise Control

Long press the **[C]** button for 2 seconds to activate the Cruise Control when the speed reaches at least 5mph.



USB Port Charge

Your eBike can charge your other devices via the USB/Type-C charging port located in the back of the control panel.

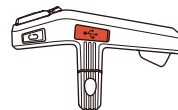

SensorSwap™

Your eBike can choose between a Torque sensor and a Cadence sensor, responding to pedaling force or speed.



Riding Data

Single press the **[M]** button to cycle through various riding data:

- TRIP DIST.
- TRIP TIME
- EST. RANGE
- CO₂ SAVED

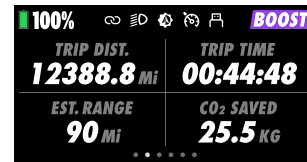

- MAX SPEED
- AVG. SPEED
- ODO.
- TOTAL TIME

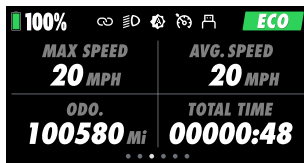

- MOTOR TEMP.
- OTRL. TEMP.
- CADENCE
- CALORIES

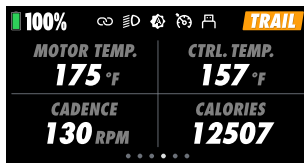

- HEART RATE
- AVG. HR

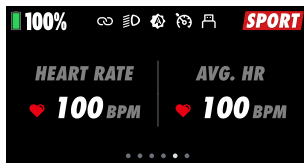

- RIDER POWER
- BIKE POWER

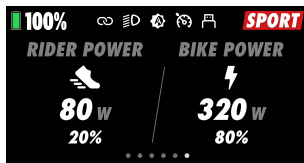

Turn Signal

Single press the button to turn on the left turn signal. The left side rear light will blink.

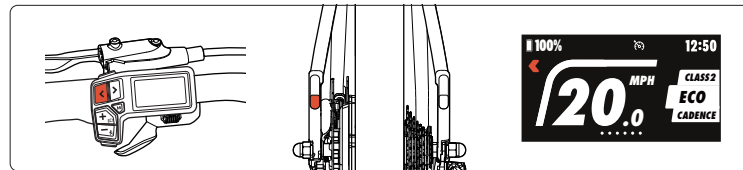

Single press the button to turn on the right turn signal. The right side rear light will blink.

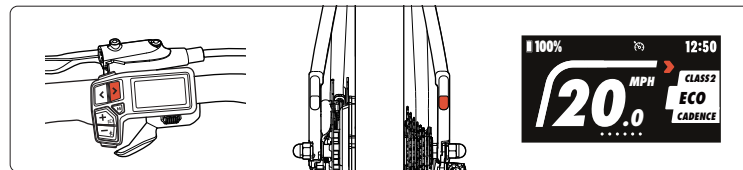

Error Code

When the eBike electronic control system fails, the display will automatically indicate the error code. For the definition of detailed error codes, please refer to "eBike Error Code" and "Battery Error Code".

Note The error code will disappear when the error is solved.

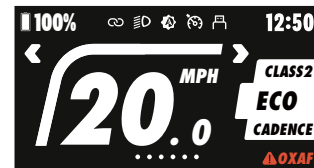

MENU Setting

When there is no speed in the power on state, long press the **(M)** button for 2 seconds to enter MENU.

Single press the **(+)** or **(-)** button to select display settings.

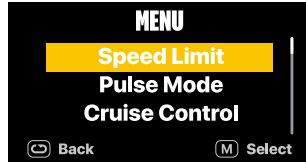

Speed Limit Setting

1. Select Speed Limit from the menu and press **(M)** to enter the settings.

2. Use **(←)** or **(→)** to choose the Class (e.g., Class 1/2/3). The selected class will be highlighted in yellow.

3. Use **(+)** or **(-)** to switch between Pedal and Throttle modes. Unavailable modes are shown in gray.

4. Use **(←)** or **(→)** to adjust speed for the selected mode.

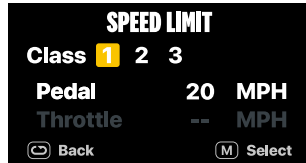

5. Press **(M)** to save settings. A "Success" message will appear. If you exit without saving, changes will not apply. Press **(←)** to return to the previous menu.

6. In Custom mode, after pressing **(M)** to save, a red warning will appear:

"Please adjust mph according to your local eBike traffic rules." Press **(M)** again to confirm and complete the save.

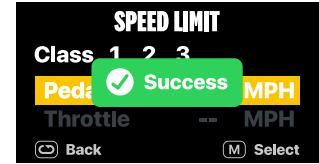

Pulse Mode Setting

1. Select Pulse Mode from the menu and press **(M)** to enter the settings.

2. Single press the **(←)** or **(→)** button to turn on/off Pulse Mode.

When Pulse Mode is activated:

- The sensor mode is fixed to Torque and cannot be changed.
- The speed limit is set to Class 3, allowing pedaling up to 28 MPH, while the throttle is disabled.
- The display interface automatically switches to the Pulse screen.

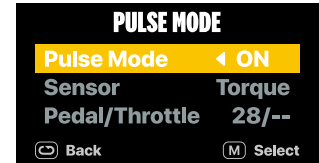

3. Single press the **(M)** button to save the setting, or press the **(☰)** button to exit without saving.

Heart rate below target: Green bar, less assist, pedal more.

In target zone: Blue bar, keep steady.

Above target: Orange bar, more assist, relax and lower HR.

Zone 1 Warm-up: Ideal for warm-up or slow riding

Zone 2 Fat Burn: Best for fat loss, suitable for beginners; sustain for 30+ minutes

Zone 3 Aerobic Endurance: Improves cardio fitness, suitable for long sessions

Zone 4 Anaerobic Endurance: For interval training or short sprints

Zone 5 Max Effort: Pushes limits, for professional training; use with caution

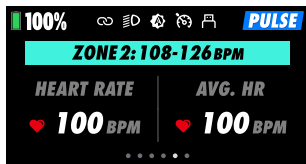
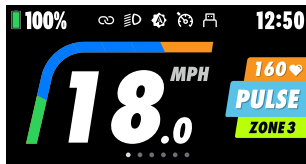

Cruise Control Setting

1. Long press the **(M)** button to open the settings page, navigate to Cruise Control with the **(☰)** button, and press **(M)** to enter.
2. Single press the **(←)** or **(→)** button to turn on/off Cruise Control. The setting options are ON and OFF. The default value is OFF. If it is ON, you can use cruise control function during riding and Cruise Control will allow your eBike to maintain a constant speed.
3. Single press the **(M)** button to save the setting, or press the **(☰)** button to exit without saving.

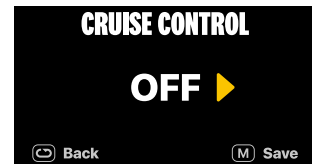

How to activate Cruise Control

If the Cruise Control setting is ON, long press the **(☰)** button for 2 seconds to enter cruise control mode if the speed reaches 5mph.

How to deactivate Cruise Control

There are four ways to deactivate Cruise Control:

1. Pull either brake lever
2. Switch assist level.
3. Switch riding mode
4. Push the throttle

SensorSwap™ Setting

1. Long press the **(M)** button to open the settings page, navigate to SensorSwap with the **(-)** button, and press **(M)** to enter.
2. Single press the **(←)** or **(→)** button to swap sensor. The setting options are torque and cadence. The default value is torque.
3. Single press the **(M)** button to save the setting, or press the **(⏪)** button to exit without saving.

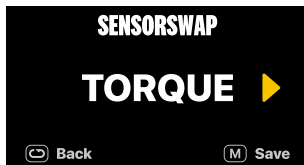

Experience Setting

1. In the menu, select Experience, then press the **(M)** button to enter the settings interface.
2. Use the **(+)** or **(-)** buttons to switch between parameters (Riding / Throttle). The currently selected parameter will be highlighted in yellow.
3. For each parameter, use the **(←)** and **(→)** buttons to select the desired option.
4. After completing the settings, press the **(M)** button to save your changes.



Clear Trip Data

1. Long press the **(M)** button to open the settings page, navigate to Clear Trip Data with the **(-)** button, and press **(M)** to enter.
2. Single press the **(M)** button to reset the trip distance, trip time, average speed, max speed, calories burned and CO₂ saved.
3. Single press the **(M)** button to reset the data, or press the **(⏪)** button to exit without saving.

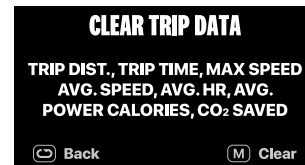

NFC Card Setting

Enable or Disable NFC Unlock

Go to the NFC CARD settings page.

Use **(+)** or **(-)** to select an NFC card, then use **(←)** or **(→)** to toggle between "ON" or "OFF".

ON: Enables NFC unlock function

OFF: Disables NFC unlock function

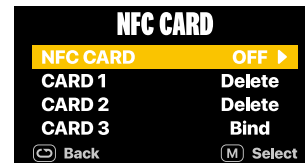

Bind an NFC Card

Go to the NFC CARD settings page.

Use (+) or (-) to select a card slot (status shown as "Bind"), then press (M) to begin binding.

The NFC icon on the screen will flash at 400ms intervals to indicate it's ready for binding.

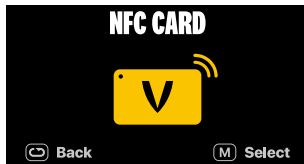

When a card is successfully detected and bound, a message will appear: "Card detected, Connect the app in case it gets lost."

A confirmation sound is also played.

Press (C) or (M) to return to the NFC CARD settings screen and proceed with other actions.

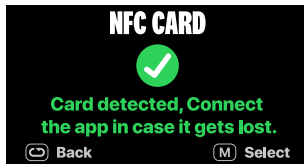

If binding fails or the card is already bound, one of the following messages will appear:

"Fail to Add the Card, Please Try Again."

"This Card Has Been Bound."

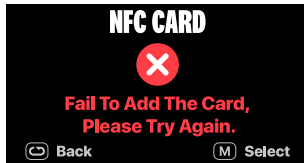

Delete an NFC Card

1. Use (+) or (-) to select a bound NFC card.

2. Press (M) to enter the deletion confirmation screen. In the pop-up, use (L), (R), (+), (-) to switch between "Cancel" and "Confirm".

3. Press (M) again to confirm your choice.

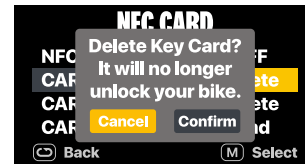

If deletion is successful:

A green "Success" toast will appear for 1 second.

The system remains on the NFC CARD settings screen for further operations.

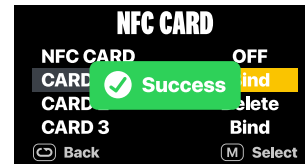

If deletion fails:

A red "Failed" warning will appear.

The bound status remains unchanged.

The message disappears after 1 second, and the user stays on the NFC CARD settings screen.

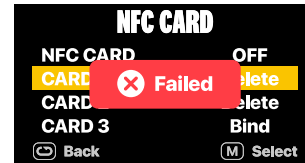

Heart Rate Connect Setting

First-Time Connection

In the menu, select Heart Rate Connect and press **[M]** to enter the setup page. The system will automatically begin scanning for nearby Bluetooth devices. Press **[C]** at any time to cancel scanning and return to the main menu.

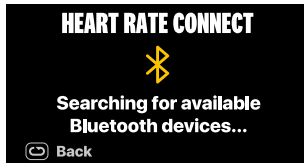

Available devices will be listed. Unpaired devices are shown in gray with a gray heart icon.

1. Use **[+]** or **[-]** to scroll through the list. The selected device is highlighted in yellow.
2. Press **[M]** to connect with the selected device.
3. Press **[C]** to cancel and discard changes.

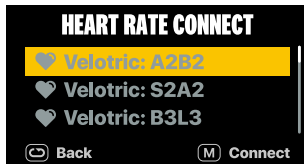

if search failed:

If no devices are found, the system displays: "No heart rate devices found"

Two options are shown:

[C]: Return to the previous menu

[M]: Rescan for devices

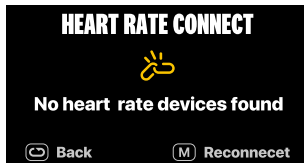

Reconnecting Stored Device Select Heart Rate in the menu and press **[M]**. If a previously paired device exists, the system will display the device directly without scanning.

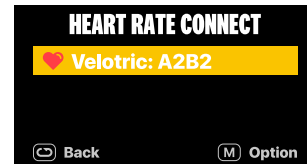

If Auto-Connection is Successful:

Press **[M]** to manage the connected device. A prompt appears: "You have the option to unbind or delete this device." Use **[<]**, **[>]**, **[+]**, **[-]** to switch between Delete and Unbind. Press **[M]** to confirm.

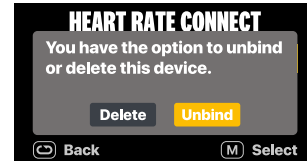

If choose Delete:

A warning prompt appears: "This operation will remove the current device and start a new search to bind a new one." Use **[<]**, **[>]**, **[+]**, **[-]** to choose Confirm or Cancel. Press **[M]** to proceed.

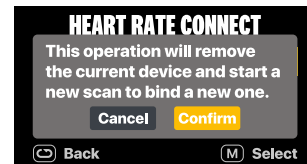

If Auto-Connection Fails:

Press **(M)** to manually bind or delete the device.

Prompt: "You have the option to bind or delete this device."

Bind:

A green "Connected" toast appears for 1 second. Stays on Heart Rate page for further operations.

Delete:

Same flow as above:

Confirm to delete and restart scanning.

Cancel to keep current setting.

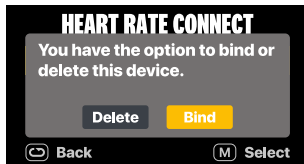

Rear Light Mode Setting

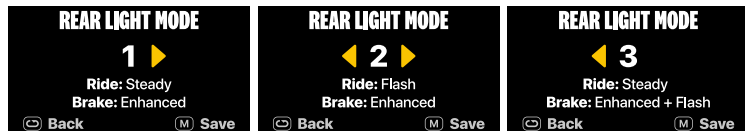

1. Long press the **(M)** button to open the settings page, navigate to Rear Light Mode with the **(←)** button, and press **(M)** to enter.

2. Single press the **(←)** or **(→)** button to switch rear light mode. The default value is 1. The setting options are 1, 2, 3.

Mode 1: The rear light is steady while riding and enhanced while braking.

Mode 2: The rear light flashes while riding and enhanced while braking.

Mode 3: The rear light is steady while riding and enhanced with flashing while braking.

3. Single press the **(M)** button to save the setting, or press the **(↩)** button to exit without saving.

Turn Signal Click Setting

1. Long press the **(M)** Button to enter the setting page.

2. Single press the **(←)** or **(→)** button to turn on/off turn signal click. The sound is enabled by default.

3. Single press the **(M)** button to save the setting.

4. Single press the **(↩)** button to exit without saving the setting.

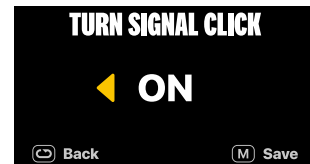

Auto Light Setting

1. Long press the **[M]** button to open the settings page, navigate to Auto Light with the **[←]** button, and press **[M]** to enter.
2. Single press the **[←]** or **[→]** button to turn on/off Auto Light. The default value is ON. If it is ON, the front and rear lights will be turned on/off automatically when it detects the surrounding area is dark enough. It will also turn the front and rear lights off if it believes your surroundings are bright enough.
3. Single press the **[M]** button to save the setting, or press the **[↶]** button to exit without saving.

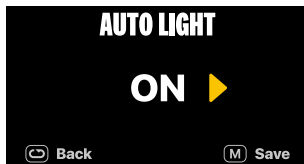

Note If you manually turn on/off the front and rear lights via the handlebar remote, the Auto Light will no longer automatically activate or deactivate the front and rear lights until the next time you power on the eBike. This is so that the ambient light sensor does not override your preferences.

Screen Brightness Setting

1. Long press the **[M]** button to open the settings page, navigate to Screen Brightness with the **[←]** button, and press **[M]** to enter.
2. Single press the **[←]** or **[→]** button to adjust screen brightness. The setting options are 1-5 and Auto. 1 is the darkest, 5 is the brightest, "Auto" means the display will detect the brightness automatically. The default value is Auto.
3. Single press the **[M]** button to save the setting, or press the **[↶]** button to exit without saving.

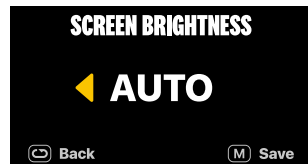

Auto Power Off Setting

1. Long press the **[M]** button to open the settings page, navigate to Auto Power Off with the **[←]** button, and press **[M]** to enter.
2. Single press the **[←]** or **[→]** button to adjust the 'Auto Power Off' time. The setting options are 5, 10, 30, 60 minutes and OFF. The default value is 5 minutes. Your eBike will automatically power off itself after sitting idle for a few minutes. The OFF means the eBike will never power off itself automatically.
3. Single press the **[M]** button to save the setting, or press the **[↶]** button to exit without saving.

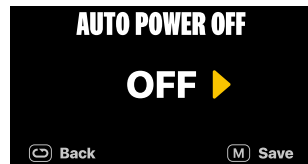

Note Your eBike won't power off itself automatically if it is in USB Port charging.

Sensor Calibration

1. Long press the **(M)** button to open the settings page, navigate to Sensor Calibration with the **(←)** button, and press **(M)** to enter.
2. Ensure there are no objects on the pedals and that the pedals are not being pressed.
3. Single press the **(M)** button to confirm the setting, or press the **(↶)** button to exit without saving.

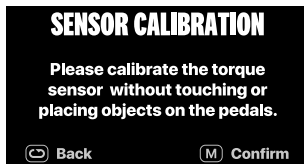

Ride Tuning Setting

1. From the menu, select Ride Tuning, then press **(M)** to enter the settings page.
2. Use **(←)** or **(→)** to choose a riding mode: ECO, TOUR, TRAIL, SPORT, or BOOST. The selected mode will be highlighted in a bright color.
3. After selecting a mode, do not press **(M)** again. Press **(←)** directly to start tuning.

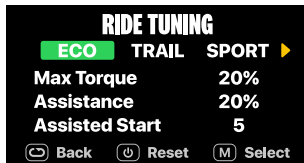

- a. Switch parameter items:

Use **(+)** or **(-)** to cycle through parameters (e.g., Max Torque, Assistance, Assisted Start). You can also press **(+)** to return to mode selection.

The selected item is highlighted in yellow.

- b. Adjust parameter values:

Use **(←)** or **(→)** to increase or decrease the selected value.

4. After adjustment, press **(M)** to save. Press **(↶)** to return to the previous menu. If you didn't press **(M)** to save, all changes will be discarded. Press the **(↷)** button to restore default settings.

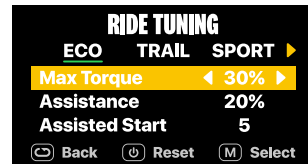

Throttle Sync Setting

1. Long press the **(M)** button to open the settings page, navigate to Throttle Sync with the **(←)** button, and press **(M)** to enter.
2. Single press the **(←)** or **(→)** button to turn on/off Torque Mode Throttle Limited. The default setting is OFF. When ON, throttle speed in Torque Mode follows the assist level limit; when OFF, it matches the throttle speed limit.
3. Single press the **(+)** or **(-)** button to toggle between Torque Mode Throttle Limited and Cadence Mode Throttle Limited.
4. Single press the **(M)** button to save the setting, or press the **(↶)** button to exit without saving.

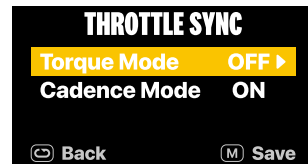

Time Setting

1. In the menu, select Time Setting and press **(M)** to enter.

2. Use **(+)** or **(-)** to adjust hours and minutes, Both increase and decrease directions are supported.

3. Use **(<)** or **(>)** to switch focus between hour and minute fields.

4. After setting the desired time, press **(M)** to save:

To cancel or return without saving, press **(⏪)**.

Unsaved changes will be discarded.

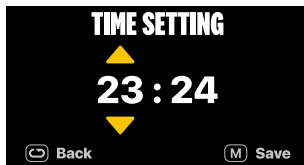

Version Info

1. Long press the **(M)** button to open the settings page, navigate to Version Info with the **(-)** button, and press **(M)** to enter.

2. This page will show the firmware version of display, controller, battery.

3. Single press the **(⏪)** button to exit.

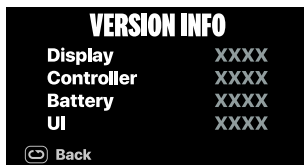

MAINTENANCE & CARE

Follow these guidelines to ensure safe riding and extend your eBike's lifespan. Poor maintenance can lead to failure or hazards. Higher usage requires more frequent maintenance. Repair faults immediately. Replace worn parts promptly. Seek professional service or dealer assistance when needed.

Maintenance Schedule

86

Storage Guidelines

87

Maintenance Schedule

Weekly Checks

- Check fastener tightness (torque).
- Check drivetrain alignment and smooth operation (chain, cassette, crankset, derailleur).
- Check wheels are true (no wobble or spoke noise).
- Inspect frame and welds for damage.
- Inspect and test brake pads.
- Check tire pressure.
- Clean frame with a damp cloth and mild soap (as needed).
- Clean and lubricate the chain.
- Adjust derailleur/brake cable tension if needed.
- Replace any worn/damaged parts.

Monthly Checks

- Check brake pad wear and cable tension.
- Check shifting system.
- Check chain for stretch (wear).
- Inspect brake & shift cables/housings for corrosion or wear.
- Check wheel rims and spoke tension.
- Tighten all accessories (fenders, racks, reflectors) to prevent interference.
- Service fork and brake system.
- Clean and lubricate drivetrain.
- Clean brake and shift cables/housings.
- True wheels if spokes are loose.

- Replace brake/shift cables/housings if needed.
- Replace brake pads if worn.
- Clean brake rotors.

Every 6 Months

- Inspect drivetrain (chain, chainrings, cassette, derailleur).
- Inspect all cables and housings.
- Have a professional tune-up.
- Grease the bottom bracket bearings.
- Replace brake pads if worn.
- Replace tires if worn.
- Replace brake/shift cables/housings if needed.

Storage Guidelines

General Storage

- For long-term storage, remove the battery (see "Battery Storage").
- Store the bike in a clean, dry, ventilated area at 50°F - 77°F (10°C - 25°C).
- Store indoors. Avoid direct sunlight, high heat, and moisture.
- Secure the bike with a lock to deter theft.
- Snow, rain, road salt, and acids can cause corrosion.
- UV sunlight can fade paint and degrade rubber/plastic.
- Extreme temperatures during storage can cause temporary issues or permanent damage.
- Direct sunlight can damage the display.
- Water damage and corrosion are not covered under warranty.

Winter Storage

- Velotric Batteries have Low-Temperature Protection: Below 32°F (0°C), the battery enters protection mode and will not charge to prevent damage.
- To exit protection mode, warm the battery to above 50°F (10°C) for at least 1 hour.

Battery Storage

▲ WARNING Battery overheating can cause fire or explosion. Always store battery and charger in a ventilated, temperature-controlled area.

- Avoid water, corrosive substances, and heat sources.
- DO NOT store the battery ON the bike.
- Store in a clean, dry, ventilated area at 50°F - 77°F (10°C - 25°C).
- Keep away from children and pets.
- Do NOT place objects on, lean on, or hang items from the battery.
- Avoid corrosive chemicals or vapors.
- For long-term storage, maintain charge level between 60% - 80%. Charge if below 60%.
- Remove battery, place on a flat, dry surface.
- Apply dielectric grease to terminals to prevent moisture/corrosion.
- Avoid impacts (e.g., dropping).

Cleaning Guide

▲ WARNING

- DO NOT hose down or pressure wash the bike. Water ingress can cause injury or failure.
- DO NOT use grease/oily cloths on electrical connectors, brake rotors, tires, or plastic.
- DO NOT use harsh cleaners; they can damage finishes and parts.

- Clean painted/plastic parts with a soft, damp cloth and mild soap. Dry thoroughly.
- Clean display surface with a soft cloth dampened with water only. NO cleaners or sprays.

Chain Cleaning & Lubrication Guide

Proper chain maintenance ensures smooth riding and extends drivetrain lifespan.

- Clean the chain using a dedicated degreaser or chain cleaning tool. If unavailable, use a soft brush and mild degreaser.
- Rinse with clean water or mild neutral detergent to remove any remaining degreaser.
- Dry thoroughly with a clean cloth to ensure no moisture remains.
- Apply lubricant—use a suitable type (wet or dry) for your riding conditions, applying one small drop to each roller.
- Rotate the chain slowly, then wipe off excess oil with a clean cloth.
- Avoid high-pressure water, strong solvents, heavy oils, or greasy cloths on the chain.
- Maintenance frequency: check and lubricate the chain every month or after several hours of riding. Increase frequency for wet or muddy conditions.

Parking Guide

eBikes are heavier. Improper parking can cause tipping, leading to injury or death.

- Obey local parking laws, especially in public areas.
- Park indoors whenever possible. If outdoors, avoid prolonged exposure to rain/moisture. Dry promptly. More frequent maintenance is needed after wet exposure.
- Avoid parking in direct sunlight to protect the display.
- DO NOT park/store in hot environments (e.g., car trunk on hot day). Storage Temp Range: -4°F to 140°F (-20°C to 60°C).
- Turn off power/lights to save battery. Remove key. Lock battery on frame or remove it.
- Park near a power outlet if possible.
- Park safely away from children, pets, and traffic.

- Clean painted/plastic parts with a soft, damp cloth and mild soap. Dry thoroughly.
- Clean display surface with a soft cloth dampened with water only. NO cleaners or sprays.

TROUBLESHOOTING & SERVICE

Troubleshooting

For optimal riding, perform these basic checks if you encounter issues:

Bike Won't Start/Charge?

- Check battery level & charge.
- Ensure battery is installed correctly; clean contacts.
- Follow correct startup sequence.

Ride Feels Unstable/Noise?

- Check/tighten handlebar, stem, headset.
- Check tire pressure (match PSI on tire sidewall).
- Inspect motor/wheel for damage.

Weak Power/Poor Acceleration?

- Charge or replace low battery.
- Check throttle for sticking or damage.
- Ensure brakes aren't dragging.

Reduced Range?

- Inflate tires to correct PSI.
- Avoid overloading, headwinds, frequent braking.
- Low (<5°C / 41°F) or High (>40°C / 104°F) temps affect battery.

Battery Won't Charge?

- Check charger connections.

- Ensure ambient temp is 41°F - 104°F (5°C - 40°C).
- Deeply discharged battery may need replacement.

Motor Doesn't Respond?

- Restart bike (hold power 10 sec).
- Check wiring connections & controller.

Error Code on Display?

our Velotric has a diagnostic system. If an error code appears, scan the QR code below for information.



If the issue persists after these checks, CONTACT SERVICE SUPPORT IMMEDIATELY:

Service Hotline: +1 888-559-3099 (PST: 7 AM - 4 PM, Mon - Fri)

Email: help@velotricbike.com

(Include: Owner Name/Contact Info/Order Number/Purchase Channel/Model/Frame Number (on bottom bracket))

We'll provide efficient solutions for worry-free riding.

WARRANTY POLICY

Limited Warranty Terms	96
This Limited Warranty Does Not Cover	96

Limited Warranty Terms

All Velopower, Inc. eBikes (the “eBike”), and their individual Covered Components (as defined herein), are protected against all manufacturing defects in material or workmanship for two (2) year after receipt of the eBike by the customer (the “Warranty Period”). This Limited Warranty is only applicable to United States eBike purchases (purchases in Canada and the European Union shall be subject to their respective warranty terms) and in accordance with the following terms:

- Only the first owner (original purchaser) of an eBike purchased from Velopower, Inc.’s online or physical storefront is covered by this Limited Warranty. Please note that bikes purchased from authorized dealers are covered by the warranty provided by the respective dealer. The Warranty Period begins upon your receipt of the eBike and shall end immediately upon the end of the Warranty Period or any sale or transfer of the eBike to another person, and under no circumstances shall the Limited Warranty apply to any subsequent owner or other transferee of the eBike.
- The Limited Warranty is expressly limited to the replacement of a defective lithium ion battery (the “Battery”), frame, forks, motor, motor controller, display, throttle, brake, front light, rear light and charger (each a “Covered Component”).
- The Covered Components are warranted defect-free in materials and/or workmanship during their respective Warranty Periods as detailed in the official website’s Warranty Policy.

▲ Notice Velopower, Inc. will revise our warranty terms in response to market performance and user requirements. Please refer to the most current warranty information available on our website.
(<https://www.velotricbike.com/pages/warranty>).

This Limited Warranty Does Not Cover

- Normal wear and tear of any Covered Component (as mentioned above).
- Consumables or normal wear and tear parts (including without limitation tires, tubes, brake pads, cables and housing, grips, chain and spokes).

- Any damage or defects to Covered Components resulting from failure to follow instructions in the eBike owner’s manual, acts of God, accident, misuse, neglect, abuse, commercial use, alterations, modification, improper assembly, installation of parts or accessories not originally intended or compatible with the eBike as sold, operator error, water damage, extreme riding, stunt riding, or improper maintenance.
- For the avoidance of doubt, Velopower, Inc. will not be liable and/or responsible for any damage caused by use, speed unlock, hardware or software modifications, failure or loss caused by any unauthorized service or use of unauthorized parts.
- The Battery is not warranted from damage resulting from power surges, use of an improper charger, improper maintenance or other such misuse, normal wear or water damage.
- Any products sold by Velopower, Inc. that is not an eBike.
- Damage to a Covered Component during shipping is not covered by this Limited Warranty.

DETERMINING WHETHER DAMAGE OR DEFECT TO AN eBike OR COVERED COMPONENT IS PROTECTED BY THIS LIMITED WARRANTY SHALL BE IN THE SOLE DISCRETION OF VELOPOWER, INC.

Spin the Wheels, Join the Fun.



Join our Facebook group and follow us on Instagram.

Register your 2-Year Warranty Today!



Scan the QR code to register your eBike warranty.



The Apple Find My network provides an easy, secure way to locate compatible personal items using the Find My app on your iPhone, iPad, Mac, or the Find Items app on Apple Watch.

To use the Apple Find My app to locate this item, the latest version of iOS, iPadOS, or macOS is recommended. The Find Items app on Apple Watch requires the latest version of watchOS.

Use of the Works with Apple badge means that a product has been designed to work specifically with the technology identified in the badge and has been certified by the product manufacturer to meet Apple Find My network product specifications and requirements. Apple is not responsible for the operation of this device or use of this product or its compliance with safety and regulatory standards.

Apple, Apple Find My, Apple Watch, Find My, iPhone, iPad, iPadOS, Mac, macOS and watchOS are trademarks of Apple Inc. IOS is a trademark or registered trademark of Cisco in the U.S. and other countries and is used under license.



Find Hub helps you find and connect to what matters in a single, secure place. Find your belongings quickly and safely – even if your devices are offline. Plus, seamlessly and securely share your location with friends & family for peace of mind.

Find Hub network requires location services and Bluetooth to be turned on. Requires cell service or internet connection. Works on Android™ 9 and above on select devices [devices or phones] and in certain countries for age-eligible users.

This device can work with either the Apple Find My network or Find Hub, but these two services cannot operate simultaneously. Activating one will automatically disable the other.

Android is a trademark of Google LLC.

This product has been certified by Google to meet Find Hub network accessory specifications. Google is not responsible for the operation of this product. Google is also not responsible for ensuring that the product complies with any applicable safety standards or other requirements.

VELOTRIC

Contact

Website: www.velotricbike.com

E-mail: help@velotricbike.com

V1.0